

SEED PROCESSING AND STORAGE

Principles and practices of seed harvesting, processing, and storage: an organic seed production manual for seed growers in the Mid-Atlantic and Southern U.S.

Copyright © 2004 - 2010 by Jeffrey H. McCormack, Ph.D.
Some rights reserved. See page 28 for distribution and licensing information.

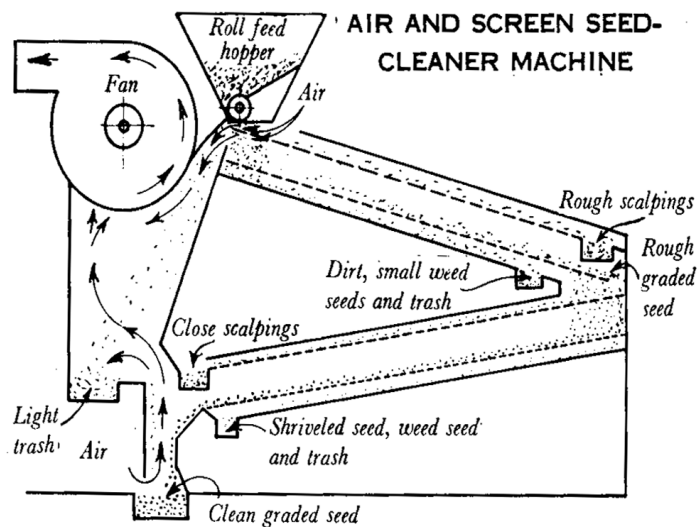

For updates and additional resources, visit www.savingourseeds.org
For comments, suggestions, or distribution information contact:

Jeffrey H. McCormack, Ph.D.
Saving our Seeds
www.savingourseeds.org
Charlottesville, VA 22911

Funding for this project was provided by USDA-CREES (Cooperative State Research, Education, and Extension Service) through Southern SARE (Sustainable Agriculture Research and Education).

TABLE OF CONTENTS

| | |
|--|----|
| Principles of seed harvesting and processing..... | 3 |
| Seed harvesting and extraction..... | 3 |
| Harvesting..... | 3 |
| Dry seed processing..... | 3 |
| Wet seed processing..... | 4 |
| Seed processing and handling | 6 |
| Threshing equipment | 6 |
| Seed cleaning equipment (seed screens)..... | 6 |
| Winnowing equipment | 7 |
| Seed drying..... | 8 |
| Principles of drying..... | 8 |
| Drying seeds for long-term storage..... | 8 |
| Instructions for drying seed with silica gel..... | 9 |
| Seed storage.. | 9 |
| Effect of temperature on seed longevity | 9 |
| Effect of seed moisture and humidity on seed longevity..... | 9 |
| Relationship between relative humidity and seed moisture content | 10 |
| Determining seed moisture content | 10 |
| Relationship between temperature and moisture on seed longevity..... | 11 |
| Illumination..... | 11 |
| Respiration and heating..... | 11 |
| Effects of fungi, bacteria, and pests on seed storage..... | 12 |
| Variety and harvest conditions | 12 |
| Seed moisture levels required for long-term seed storage..... | 12 |
| Packaging materials and containers for seed storage..... | 14 |
| Seed longevity..... | 15 |
| Relationship between viability and vigor..... | 15 |
| Expected life span of stored seed..... | 17 |
| Seed dormancy | 17 |
| Federal and state seed laws..... | 18 |
| Seed treatments | 19 |
| Germination testing | 19 |
| Basic procedures for doing your own tests | 19 |
| Testing by laboratories | 20 |
| Germination enhancement techniques | 20 |
| Mixing seed lots of the same variety | 20 |
| Additional seed processing..... | 20 |
| Brief microwave treatment..... | 21 |
| Other techniques..... | 21 |
| Seed statistics..... | 21 |
| Labeling and record keeping | 22 |
| Shipping seeds..... | 22 |
| Prior to shipment | 22 |
| Containers for shipping..... | 22 |
| Appendix A: Hot water treatment times (in minutes) for vegetable seed..... | 23 |
| Appendix B: Vegetable seed data, germination information, and federal standards..... | 24 |
| Appendix C: Basic seed cleaning equipment | 25 |
| Sources of supplies and equipment..... | 26 |
| Selected bibliography and literature cited | 26 |
| Licensing and distribution information..... | 28 |

PRINCIPLES OF SEED HARVESTING AND PROCESSING

The primary purpose of storing seeds is to save seed from one season to the next, but farmers and seed companies often find it useful or necessary to store seeds for at least two to three years, and sometimes longer.

There are several reasons for this: (1) seed yields and seed quality (germination and vigor) may be unpredictable due to growing conditions, and (2), market demand for certain crops may vary significantly from one year to the next. Market demand itself can be strongly influenced by media coverage of certain varieties that may quickly fall in or out of favor depending on media exposure. Likewise, market demand may also be influenced by the psychological effects of poor growing conditions from the previous season. For example, gardeners coming off of two years of drought may become discouraged from making purchases for the next season. National events (such as war, disasters, or media “feeding frenzies”) during peak ordering season can have a strong effect on seed sales. Cold, cloudy, winter weather, lingering late into spring can have an effect on impulse purchases by casual gardeners. Though sales to market growers tend to be more predictable from year to year, many gardeners may purchase more on impulse. Because of all these factors, seed demand is not precisely predictable. As a consequence much of the seed sold in commerce is not sold the year after it was produced. Seed is routinely carried over from year to year, and germination tested on a regular basis.

Because seed is routinely stored for more than one year, it is important to understand how seed harvesting, processing and seed storage affect the longevity and vigor of the seed. Seeds are fragile, living organisms, and the shelf life of the seed is affected at the beginning of the plant life cycle by such factors as soil nutrition. For example, if the soil is zinc deficient, the quality of the seed will be adversely affected. (Zinc is a co-factor in many enzyme reactions in the life of the seed and the maternal plant.) Though providing the best conditions for crop growth and health is the foundation of seed quality, the factors that can have the most important effect on seed viability and vigor are harvesting, extraction, cleaning, transportation, and storage. It is easy for seed to become damaged at any of these stages. The purpose of this publication is to provide guidelines for minimizing seed damage and maximizing seed viability and vigor from pre-harvest through post-harvest processing.

SEED HARVESTING AND EXTRACTION

Seed harvesting and cleaning methods can be divided into two methods: dry processing and wet processing. Dry processing involves harvesting seed that has already matured and dried within the seed-bearing portion of the plant. Examples of dry processed seed plants include beans, broccoli, corn, lettuce, okra, onions, sunflower, and turnips. Wet processing is used when the mature seed is enclosed within a fleshy fruit or berry. Examples of wet processed seed plants include cucumbers, melons, and tomatoes. Some vegetables can be either dry processed or wet processed, for example, peppers, and squash.

Harvesting:

The basic rule of harvesting is to allow the seed to mature as long as possible on the plant without the seed or fruit becoming diseased, or overly ripe. Each type of plant has an optimum time for collecting the seed, but factors such as climate, weather, disease, insects, birds, or predatory mammals may require that the seed be collected at less than the optimum time. In the Mid-Atlantic and South, frequent and daily thunderstorms and high humidity may play a large role in determining how and when seed is harvested. For example, in dry climates, beans can normally be left to mature and dry in the field, but during wet humid weather, it is best to harvest early and allow the beans to continue maturing and drying under cover.

Dry seed processing (pods, capsules, seed heads, etc.):

When seeds are ready to be processed, the entire seedpod, capsule, or seed head will become brown and dry. During the maturation process, the ripening pods and capsules change color from green, to yellow-green, to yellow, to light brown, to a darker brown, or dark gray. Ripening and maturation may be uneven within the pod or capsule, uneven on the plant, and uneven within the stand of plants. For that reason, the pods of many plants are harvested individually. Seeds of legumes and brassicas often develop a split along one side of the pod. This is the best time to collect the seed, before the pods start to open and scatter their seed. Most flower seed heads are not ready to harvest until the flower head has dried completely to the base,

including a short section (approximately ¼”) of the supporting stem. Some plant families, such as the Asteraceae (Aster family) have a smaller percentage of viable seed in the head, and the seeds continue to mature after collection. For this reason it is best not to be too hasty in harvesting the seed. Examples include lettuce and sunflower. Some seed may mature in the capsule or pod, even before the pod has turned completely brown. Most seeds turn a darker color as they mature. Seeds may initially be white, turning green or tan, and then brown or black. Once the seed pods, capsules, and seed heads start to mature, it is important to check the crop on a daily basis. Rain or seed predators can ruin a good seed crop in a short period of time. Plants that produce umbels (members of the carrot family, or Umbelliferae) can usually be left in the field to harvest until the umbels are dry. Some members of this family mature their seed unevenly causing seed to scatter, while other seeds in the umbel continue to mature. One method of dealing with crops that mature their seed unevenly is to pull the plants and hang them upside down to dry under cover. This allows the seed to continue to mature on the plant while the plant dries. This procedure is often used for lettuce. Confidence in knowing when to harvest comes both with experience and familiarity with different species and crops.

After harvest, seeds are threshed to remove the seed from the surrounding plant material. A period of air-drying is important before seeds are threshed. Plant material should be spread out in thin layers until all plant material is dry; otherwise, mold, decay, and heat from decay will cause damage to the seeds. As the plant material dries, seed pods may split open or shed seed. Harvested material should be stored in a well-ventilated room with low humidity. During this time you should be aware of insects, especially weevils that feed on the seeds. Plant material that is ready to be threshed should be brittle. Threshing is best done outside on a dry day. The threshing process involves application of mechanical force using a controlled pressure and a shearing motion, and is accomplished by hand or by machine.

There are many different methods for threshing seed. Plants that have pods, such as beans and okra, can be threshed by placing the pods in a large feed sack, which is tied shut securely, and then placed on the ground where it is flailed, stepped on, jogged on, or danced on with a twisting motion. The sack is turned often to redistribute the plant material for further threshing. When using this method, it is best to use running shoes or other soft-soled shoes because seeds can develop hairline cracks and splits from too much pressure. To separate seed from flower heads, plant material is spread on a concrete slab and then gently walked on with a twisting motion to break open the flower heads. Care must be taken to not apply so much pressure that the seed is abraded or broken (especially a concern with angular-shaped seed). To thresh seeds of brassicas, place plant material in a large wheelbarrow or on a large tarp, and while wearing gloves twist and wring the plant material through your hands until the seed breaks free from the pods. Another method for extracting seed is to place seed heads on a piece of plywood. The seed is extracted by placing a wooden cement float above the material and then pressing and twisting until the seed breaks free. If the seed heads are small you can run a rolling pin over them. For threshing small lots of seed, a threshing box (Figure 1) may be used. This consists of a wooden box, with sides slanting outward, open at the top and on one end, and the long sides and bottom covered with corrugated-rubber floor matting. Seed is placed in the box and a rubbing board (also covered with corrugated rubber), is moved back and forth across the seed heads to separate the seed from the heads.

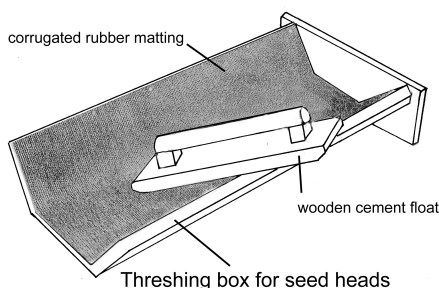

Figure 1. Threshing box for processing small amounts of seed.

Wet seed processing (crops with fleshy fruits, fermentation):

Wet seed processing is used with seed crops that have seeds in fleshy fruits or berries. There are three steps to the process: (1) extraction of the seed from the fruit, (2) washing the seeds, and (3), drying.

➤ **Extracting seed:**

The type of extraction process depends on the species. Soft fruits such as tomatoes are cut up, mashed, and then fermented. Cucumbers and melons are cut in half, the seed scraped out along with the fruit pulp surrounding the seed, and then fermented. In watermelons, the entire fleshy fruit is fermented along with the extracted seed. These types of fruits have a gel surrounding the seed that contains germination inhibitors. The presence of the gel also makes handling and drying of the seed difficult. Fermentation is a natural process that occurs to a small extent as fruits decompose. When fermentation is done in a controlled manner, the microorganisms, principally yeast, break down the gel thus releasing the seed while killing bacteria and fungi that cause most seed-borne diseases. The temperature and length of fermentation are important. If the mash is not fermented long enough, seed-borne diseases will not be eliminated, but if fermented too long, the seeds may sprout prematurely. The length of the fermentation is dependent on temperature and typically last three days at a temperature of 70 to 75°F (21°C to 24°C). Length of fermentation may also depend on the variety itself. For example, varieties with high sugar content may take longer to ferment, up to four days. With few exceptions, fermentation periods longer than three days risk damaging the seed. There are different fermentation techniques for different crops, for example, pepper seeds are extracted from the fruits by mashing, but the fermentation process may last only 24 to 48 hours. Though eggplant isn't a watery fruit, it can be mashed and fermented for about 48 hours.

A Corona® grain mill is a very handy tool to use for extracting seed of eggplants and hot peppers. The grinding plates on the mill are set wide enough apart to break up the fruit without grinding the seed. Small peppers can be put directly into the mill, whereas larger fruits such as eggplant are cut into small cubes before processing. Before processing another variety, the mill has to be disassembled and cleaned thoroughly to remove bits of small seed caught in the plates and other parts of the mill. Though some people use a food processor and blender set on low speed to extract the seed of hot peppers and eggplant, it is easy to damage the seed. I would not recommend using a blender. Instead, a food processor that has a thick (approximately 1/8") blade works well provided there is ample water in the processor, the speed is as slow as possible, and the processing time as short as possible.

There are some differences of opinion about adding water to the fermenting mixture, the concern being that water slows the fermentation process causing premature sprouting. In my experience this hasn't been a problem. As long as the ferment is not diluted more than perhaps 10 to 20 percent by volume, this isn't a concern. The issue of whether to add water depends on how thick the mash is and it depends on the variety. Some varieties make a very thick mash that is hard to stir, and others make a watery mash that stirs easily. The mash should be stirred three times a day, once in the morning, once in mid-day, and once in the evening. If the mash is too thick to stir easily, the nutrients are not going to circulate easily. Stirring is also important for better control of seed-borne diseases. In addition, when the mash is not stirred, a foul-smelling, white mold forms on top of the mash. This mold can discolor (darken) and damage seeds at the top of the mash. These seeds will later have to be hand picked out of the dried seed. A properly fermenting mash should not have a foul smell, and there should be little or no white mold on the top. A small amount of white mold is not harmful and can be stirred back into the mash, but a heavy overgrowth should be removed.

➤ **Washing seed:**

After fermentation is complete, the seeds are washed to remove pulp, pieces of fruit and debris, and low quality seed. Before washing the seed, it is useful (especially for washing tomato seed) to first scoop out pieces of pulp floating on top of the mash. This is done by straining the mash with your fingers, pulling out the larger chunks. Whether or not there is floating pulp depends on the variety or how thoroughly the fruit was processed. Add a volume of water at least equal twice the volume of mash. It is important to dilute the mash sufficiently because the more dissolved solids there are in the mash, the higher the specific gravity. If the specific gravity is high (lots of soluble solids) it will be more difficult to wash the seeds properly. As a general rule, good seeds are heavy and sink to the bottom, whereas poor quality seeds are light and tend to float off with the wash. The washing process is repeated until the wash water becomes clear. Although most good seeds sink to the bottom, some vegetables have very light seed and require extra care during the washing process. For example, it is common for a significant amount of good pepper seed to float rather than sink during the washing. This can be avoided by adding the wash water slowly, so as not to create tiny air bubbles that adhere to the seeds, making them buoyant. Even with this precaution, there are a few varieties of watermelon for example, where the good seeds tend to float rather than sink, thereby requiring special care in washing. In this case, the best way

to wash the seed is to pour the wash through a ¼” hardware cloth screen, and then use a hose to force pulp through the screen.

➤ **Drying seed:**

Seeds should be dried fairly quickly after washing. Slow drying may result in mold growth or premature sprouting of the seed. In the Mid-Atlantic and South, seeds should not be dried in the sun, nor should they be dried anywhere where the temperature exceeds 95°F (35°C). Dark colored seeds are especially vulnerable to damage when sun dried. Instead, seeds should be dried in a climate-controlled environment using fan ventilation. A combination of ceiling fans and air conditioning dries seed safely and very quickly. Seed should be spread out in thin layers (no thicker than ¼” for small seeds) and then stirred several times a day until dry. Once the seeds feel dry, they should cure for another two to three weeks. Curing is the final stage in the drying process. As the seed moisture content declines it comes into equilibrium with the relative humidity. After the seeds are cured they can be placed in a container. When drying seeds, choose plywood, window screen, or any hard, non-stick surface. Avoid using paper towels, newspaper, cardboard, or cloth because seeds will tend to stick to the surface making them difficult to remove. Beginning growers often make the mistake of drying squash seed on newspaper, which adheres permanently to the seed coat. No one wants to read the daily news on the surface of squash seed.

SEED PROCESSING AND HANDLING

Threshing: equipment:

For small-scale seed production, it is often not cost effective to purchase threshing equipment because of the small volume of seed produced. A number of small alternative seed companies, specializing in heirlooms and specialty seed, thresh most, if not all of their seed by hand. Some seed crops, especially herb and flowers seeds are produced in such small quantity (and have such small seeds) that it is impractical to use a machine for threshing. Also flowers and other seed crops, if left to dry on canvas or a tarp, naturally dehisce (shed) much of their seed. The remaining amount of seed can be released by flailing or rolling, or other non-mechanical means.

It is difficult to locate low-cost, low-tech shredders for small-scale seed threshing. The options are to locate old, used equipment or to construct your own. Vegetable seeds, such as beans can be threshed with a modified leaf shredder/chipper. Plans are available on the Web site of the University of California at Davis, Long Term Research on Agricultural Systems project:

<http://agronomy.ucdavis.edu/LTRAS/itech/thresh.html#shred>.

Typical threshing rates for this machine are 22 to 30 pounds/hour for brassicas, and approximately 100 pounds/hour for beans. The research and development group at the Organic Gardening Experimental Farm of Rodale Press developed a small-scale thresher designed to thresh a variety of crops ranging from amaranth to soybeans. Though the machine was not fully refined it did an acceptable job. Plans for this machine were published in *Small Scale Grain Raising* (see Logsdon, 1977). The book is out of print and is available from book dealers specializing in used books. Plans for building this thresher are also available (without illustrations) at the following Web address:

<http://www.geocities.com/RainForest/Vines/4095/resources/thresher.html>

Several growers have reported that small-seeded crops, such as amaranth can be threshed using an Allis-Chambers model 66 combine which is noted for its ability to thresh and clean small-seeded crops (Weber, et al., 1986).

Seed cleaning equipment (seed screens):

It is not necessary to have expensive seed cleaning equipment to clean seed for small-scale production. With the exception of lettuce seed and a few others, the majority of crop seeds can be cleaned with homemade seed screens. Winnowing will still be necessary to remove smaller chaff.

Many seeds can be screened with several different mesh sizes of hardware cloth. Hardware cloth is readily available in the following mesh sizes: 1/2", 3/8", 1/4", and 1/8". The 1/2" and 1/4" mesh sizes are available at most hardware stores. The 3/8" and 1/8" mesh sizes are the most useful sizes, but are the most difficult to find.

Aside from hardware cloth, a lot of other materials are useful for making seed screens. Aluminum window screen can be used for small seeds. You'll also find various meshes of screen available in the housewares section of department stores. Cabinets from electronic devices often have round or oblong holes which are useful for cleaning some types of seed. Special meshes can be ordered from mail-order hardware specialty catalogs. It is useful to collect a large variety of mesh sizes and shapes to handle a wide variety of seed types.

Once you have located suitable screen material it should be mounted on a frame. Professional seed screens are mounted on 12" square wooden frames. Homemade screens should also be mounted on 12" square frames so they can be used together with professional screens. The frames can be made of wooden lath which measures 3/4" x 1-1/2". Ideally, the screens should be constructed so that they nest together. The nesting feature is desirable for using three screens simultaneously: rough chaff is retained on the top screen, seeds in the middle screen, and small chaff and small seeds on the lower screen. Once the frame has been made, the screen is nailed with small nails or brads at approximately 1" intervals all along the edge of the frame.

Winnowing equipment:

The classic method of winnowing involves placing seeds in a wide basket and tossing the seeds and chaff into the air. The chaff is carried away by the wind. Illustrations of Native Americans using this historic method evoke a bucolic mood, but in reality, winnowing by this method is extremely difficult, and the results are not very satisfactory. The most vexing part of the process is that wind speed is always changing in velocity and direction. It can work for certain kinds of seed, but it actually works better to use two large bowls, pouring seed from one bowl into another bowl below, while blowing on the plant material as it falls. This method works satisfactorily if the seed is heavy and the chaff is very fine, and susceptible to being carried away by a gentle current of air. In any case, hand winnowing should be done, not on windy days, but when the air is calm.

A good range of equipment for winnowing includes the following: (1) an assortment of stainless steel bowls ranging in size from 6 to 16" in diameter, preferably bowls with varying shallow and deep sides; (2) an electric hair dryer with two speeds (heating element removed, or unheated air setting); (3) portable vacuum cleaner with option of connecting hose to the air discharge opening; (4) household box fan with three speeds; (5) squirrel cage blower; (6) rheostat for controlling fan motor speed; (7) a tarp for catching seed or chaff; and (8) a dust mask for keeping chaff out of your lungs.

Most light seed can be winnowed quickly and efficiently with mixing bowls and a hair dryer. It takes a little practice determining the correct amount of seed to put in the bowl, setting the proper fan speed, and the distance of the dryer from the bowl. It helps to jiggle the bowl up and down or to swirl the seed in the bowl. There must be little or no wind when you work with light seed. Until you have a little practice it is best to put a tarp on the ground, in case you need to sweep up your mistake and start over. Heavy seed is best winnowed by pouring the seed from one container to another in front of box fan, or alternatively directing the air discharge hose from a vacuum cleaner into a large (16" diameter) mixing bowl.

When dealing with large volumes or certain types of seed it is helpful to use mechanical equipment for winnowing. The University of California at Davis has plans for making your own winnowing equipment. This information has been available from their Long Term Research on Agricultural Systems project dealing with Appropriate Technology for Small and Subsistence Farms. Information previously on their website has moved and is no longer available, but a copy of the information may be downloaded from:

www.savingourseeds.org/resources.html

SEED DRYING

Principles of drying:

Drying is a normal part of the seed maturation process. Some seeds must dry down to minimum moisture content before they can germinate. Low seed moisture content is a pre-requisite for long-term storage, and is the most important factor affecting longevity. Seeds lose viability and vigor during processing and storage mainly because of high seed moisture content (seed moisture greater than 18%). High seed moisture causes a number of problems:

- Moisture increases the respiration rate of seeds, which in turn raises seed temperature. For example, in large-scale commercial seed storage, respiring seeds may generate enough heat to kill the seeds quickly, or to even start a fire if not dried sufficiently. Small-scale growers are not likely to have such an extreme condition, but seed longevity will, nevertheless be affected.
- Mold growth will be encouraged by moisture, damaging the seeds either slowly or quickly, depending on the moisture content of the seeds. Some molds that don't grow well at room temperature may grow well at low temperatures causing damage to refrigerated seeds. In such a case there may be no visual sign of damage.
- Unless seed moisture is at least eight percent or below, insects such as weevils can breed causing rapid destruction of seeds in a short period of time.

Drying seeds for long-term storage:

Silica gel is the most effective desiccant (moisture absorbing material) for drying seeds. Powdered milk has been recommended as a desiccant in older seed-saving literature, but is less than ten percent as effective as silica gel. Silica gel is a highly porous form of silica that absorbs moisture. It is available as a powder or as beads in different sizes. The best size bead for drying seeds is approximately 1/16" to 1/8" in diameter

"Color-indicating" silica gel is a form of silica gel that has been treated with a small amount of cobalt chloride which acts as a moisture indicator. When the indicator gel is completely dry it is a deep blue color. As the gel absorbs moisture from the air, it gradually changes in color from deep blue to light pink.

Though silica gel is clearly allowable under the Organic Rules, color-indicating silica gel is not clearly covered. Check with your certifier before using color-indicating silica gel.

Silica gel can be repeatedly reactivated (re-dried) after it has absorbed moisture. The procedure involves heating the gel and driving off the moisture, and as it dries the color gradually changes to deep blue. Drying must be done in a controlled fashion, otherwise the beads will turn black, and the moisture-absorbing capacity of the beads will be destroyed. There are two methods for reactivating silica gel:

➤ **Oven-drying method:**

This method gives the best results, but it takes longer and uses more energy. Set the oven for a temperature of at least 200°F, but no higher than 275°F. Remember, that some ovens may run hotter than the set temperature. Place the silica gel in a thick-walled Pyrex dish, no deeper than one inch, and continue heating until the beads turn deep blue. When drying large quantities (a pound or more), the gel should be stirred occasionally. The oven drying method takes 1-1/2 hours per quart of gel (with the oven temperature set at 275°F). One quart of silica gel weighs approximately 30 ounces (1.9 pounds).

➤ **Microwave-drying method:**

The microwave method works much faster but must be monitored more closely to avoid overheating the gel. Use only a thick-walled Pyrex container for heating the gel. Set the microwave on medium or medium high and dry for approximately three to five minutes. The color change in the gel can be monitored through the over door, but the gel should be inspected and stirred at the end of each heating cycle. If the gel has not dried, heat again for another three to five minutes. Approximate drying time is eight to twelve minutes per pound of gel, though actual heating time will depend according to the type of microwave.

There are some fine points and cautionary notes about using silica gel. When using a Pyrex dish, the glass should be thick. Do not use plastic microwave containers that will melt on contact with the gel. Silica gel gets very hot, and the glass container may shatter if it is too thin, of the wrong type, or if unevenly heated. You may notice a slight odor during heating. This is due to either overheating the silica gel, or to the evaporation of organic seed volatiles absorbed by the silica gel during the drying process. Silica gel itself is chemically inert, non-toxic, non-corrosive, and odorless, but breathing the dust can be hazardous under prolonged and repeated exposure. For that reason, do not use the finely ground or powdered form.

Instructions for drying seed with silica gel:

- To dry seed, determine the weight of the seed to be dried, including the packets or envelopes that contain the seed. Measure out an equal weight of silica gel and place the seeds and silica gel in an airtight container for seven days. When drying seed it is important to keep the container size small in relation to the volume of seeds being dried.
- At the end of seven days, remove the packets of seed from the drying container and transfer into another airtight container, such as a Mason jar, Seed Saver Vial™ or barrier pouch. Because seeds can re-absorb moisture from the air quickly, they should be transferred quickly.

When used as directed, silica gel dries seed from 12% typical moisture content to a desired moisture content of approximately 5% for small seeds and 7% for large seeds. As a “rule of thumb”, seeds will not be damaged provided the drying time doesn’t exceed seven days. This drying time applies to humid climates, such as the Mid-Atlantic. Longer drying may drop the moisture content below 3% for small seeds and below 5% for large seeds, levels which may damage seeds or force them into dormancy. Legumes, such as beans, are especially are injured by over drying.

SEED STORAGE

Effect of temperature on seed longevity:

The general effect of temperature on longevity is that longevity increases as temperature decreases. This is true of “orthodox” seeds: that is, most seeds that follow some general “rules of thumb” regarding longevity during the storage life of the seeds. The relationship between temperature and seed longevity is that for each 10°F (5.6°C) decrease in temperature, longevity doubles (Harrington, 1972). This rule applies to seeds stored between temperatures of 32°F (0°C) and 122°F (50°C). This rule assumes that the moisture content is a constant. This is a general guideline; in reality the longevity of some vegetable species declines more rapidly than suggested by the rule, while the longevity of others declines more slowly in relation to storage temperature.

The longevity of seeds is generally not affected by subfreezing temperatures provided the moisture content is less than 14% (because ice crystals do not form). This has been established by a number of published reports as well as my own experience storing and germination testing a wide variety of vegetable, flower, and herb seeds at 20°F (-7°C) and below for periods of at least five years. I am still getting excellent germination from seed stored twenty years, which was dried to approximately five percent moisture content. This is the ideal way to store seed, especially small seed that doesn’t require much freezer space. One caveat: seed cycled in and out of the freezer too many times without redrying may cause degradation of germination

Effect of seed moisture and humidity on seed longevity:

Seed moisture has a greater effect than temperature on seed longevity (as noted in the previous section titled “principles of seed drying”). Most seeds also follow some “rules of thumb” regarding moisture and longevity. The general relationship is that for each one percent increase in seed moisture, longevity decreases by half (Harrington, 1972). This rule applies to seed with moisture content between 5 and 13%. Above 13% moisture content, seed storage fungi and increased heating due to respiration cause longevity to decline at a faster rate. Once seed moisture reaches 18 to 20%, increased respiration, and the activity of microorganisms cause rapid deterioration of the seed. At 30% moisture content, most non-dormant seeds germinate. At the low end of the moisture range, seed stored at 4 to 5% moisture content is unaffected by

seed storage fungi, but such seeds have a shorter longevity than seed stored at a slightly higher moisture content (Bewley and Black, 1985).

Relationship between relative humidity and seed moisture content:

When storing commercially grown seed, it is impractical and too costly to use desiccant to dry the seed for storage, unless the seed is small and expensive. Commercial seed is usually packaged for short or long-term storage under conditions of ambient humidity (unless special equipment is used). Because relative humidity has a significant effect on seed moisture content, it is important to understand the relationship between humidity and seed moisture.

Regardless of the type of storage conditions, the moisture content of seed eventually comes into equilibrium with the moisture in the surrounding air. The relationship between atmospheric relative humidity and seed moisture content is shown at the right in Figure 2.

The curve was derived from measurements of the average seed moisture content of ten vegetable species stored at different relative humidity. Because the curve represents an average of ten different vegetable crop species, the response of individual species may vary. For example, seeds of grains (which contain relatively high percentages of carbohydrate) will have a moisture content of 13 to 15% at 75% relative humidity, whereas seeds rich in oils (such as peanuts) can have a moisture content of 9 to 11% at the same humidity.

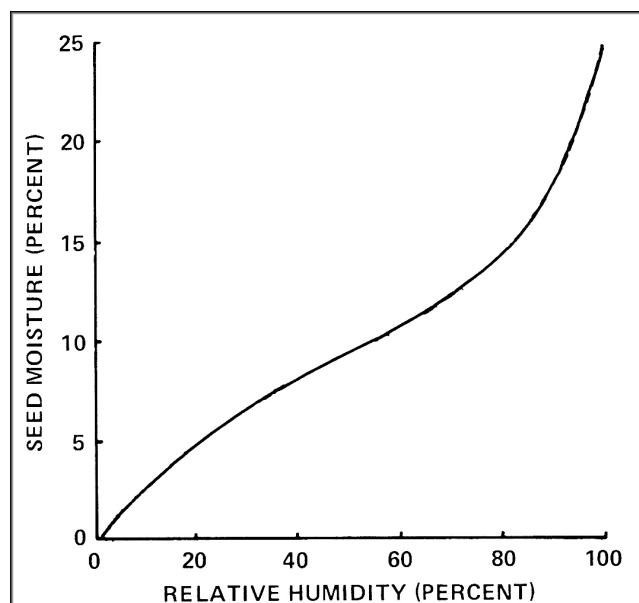

Figure 2. Relationship of vegetable seed moisture content to relative humidity. (Nakamura, 1958, as cited in Justice and Bass, 1978)

Note that once the relative humidity reaches 70%, the moisture content of the seed has reached approximately 13%, the point at which increased respiration and seed storage fungi become a significant problem. Above 70% relative humidity the moisture content rises dramatically. In central Virginia, the relative humidity in a residence or office building during the summer usually averages about 65%, plus or minus 5%. If air conditioning is used, the relative humidity typically ranges between 50 to 60%, depending on how often it runs. During the winter heating season, the relative humidity averages about 40%, plus or minus 5%. If the seed is stored in an open barn, or outbuilding, the relative humidity surrounding the seeds will be higher than that of a climate-controlled dwelling or office building. By using the values above, and referring to the chart above, it is possible to get an estimate of the moisture content of stored seed. It is clear from looking at the chart, that it is important to store seeds in a climate-controlled environment, especially during the summer.

Determining seed moisture content:

Moisture content of seed is defined by the International Seed Testing Association (ISTA) according to the following formula:

$$\text{Seed moisture content (\%)} = \frac{\text{fresh seed weight} - \text{dry seed weight}}{\text{dry seed weight}} \times 100$$

In order to determine the percent moisture content of fresh seed, a sample of fresh seed is weighed, and then an equal weight of fresh seed is dried slowly to remove the moisture, and then re-weighed. The equipment used to do this is a "seed moisture balance", which has an infrared heating lamp mounted above

the balance pan. The fresh seed is weighed in the balance pan, and then the lamp is turned on. The weight of the seed gradually decreases during heating until the weight decreases no further. Once the weight comes to equilibrium under the heating lamp, the dry weight is recorded. The data is then used in the formula above. A seed moisture balance is an expensive piece of equipment, but reliable information can be also obtained by heating the seed slowly in a toaster oven at low heat until dry, and then reweighed. Using this method it may be necessary to weigh the seed several times during drying to determine if the weight has come to equilibrium.

Relationship between temperature and moisture on seed longevity:

The effects of temperature, moisture, and relative humidity were discussed above as separate factors which affect the longevity of stored seed. In reality, the effects of temperature and relative humidity are highly interdependent in their effect on stored seed. There is a simple method for calculating the combined effects of relative humidity and temperature on seed longevity, which is as follows: the sum of the storage temperature (in degrees F), plus the relative humidity (in percent) should not exceed 100. Since seed moisture is the most important concern, the rule stipulates that no more than half the sum should be contributed by the temperature (Harrington, 1960).

The majority of crop seeds lose viability quickly when the humidity approaches 80% at temperatures of 77°F (25°C) to 86 F (30°C), but when stored at a relative humidity of 50% or less, and a temperature below 41°F (5°C), seeds will remain viable for at least ten years (Copeland, 1976).

If seeds are taken from a cold or frozen storage and transferred to room temperate, care must be taken to prevent condensation on the seeds. If the seeds are in a sealed container, allow them to sit until they reach room temperature before opening the container. If they are stored in paper, place the seeds into a plastic bag with the excess air sucked out, seal the bag,, and wait for the temperature to stabilize before unsealing.

Illumination:

The effects of light on stored seed have been studied (including the effects of different wavelengths of light): Some studies showed a benefit and some showed a detriment: the results are inconclusive and controversial.

Seeds stored in glass containers should be stored out of direct sunlight because of the localized “greenhouse heating effect” on seeds. This might seem an unnecessary and overly obvious cautionary note, but in my experience, it has happened accidentally more than once. For example, this can happen if jars of stock seed are taken outside for the purpose of removal of some seeds for planting, or for transporting to another location. Though the jar may be temporarily stored in the shade, the angle of sunlight may change quickly and the jar will be in direct sun causing very rapid heating within the jar.

Though some commercially produced seed is dried in direct sunlight (in dry climates), drying seeds in the sun is a questionable practice in the Mid-Atlantic and South if the air temperature is above 90°F (32°C). The air temperature at the seed surface is higher because of the conversion of light energy into heat at the seed surface, and the heat is “moist heat” (though this wouldn’t be in an issue in dry climates where evaporative cooling occurs at the surface). I’m not aware of any studies on this issue for our region. Another concern, also not well documented, is that the ultra-violet light from the sun may have a deleterious effect on seed longevity while the seeds are drying (Harrington, 1972). Harrington’s suggestion was based on the known effects of ultra-violet radiation on biological systems (rather than specific data). Whether the ultra-violet exposure is long enough to cause concern, is unknown.

Respiration and heating:

The largest factor affecting respiration and heating is moisture content, and therefore, at a minimum, seeds need to be kept dry. Respiration in seed storage has three effects:

1. Depletion of food reserves. Over the life of stored seed, depletion of food reserves is inconsequential.
2. Release and accumulation of gasses that may affect viability of seeds in storage. The accumulation of respiratory end products such as carbon dioxide is an advantage of storing seeds in sealed

containers where carbon dioxide replaces oxygen in the air thereby slowing down respiration and increasing longevity.

3. Release of energy, mostly in the form of heat. When seeds are stored under favorable conditions, respiration is of little consequence. When moisture is high, respiration increases, which in turn increases the production of heat thereby decreasing longevity.

Effects of fungi, bacteria, and pests on seed storage:

The process of seed harvest and cleaning removes most debris and insects, but certain fungi, bacteria, and insects make their way into stored seed. Fortunately, the same conditions that are favorable to seed preservation inhibit fungi and bacteria and kill insects.

- **Bacteria** — Bacteria do not have a significant role in seed deterioration because free water is required for bacterial growth, and if the moisture content of the seed is high enough to support bacteria, the seed is more likely to succumb to deterioration due to other causes such as fungi, respiration, heating or premature sprouting.
- **Fungi** — Most seed storage fungi are inhibited when the relative humidity is kept below 65%. At this relative humidity the moisture content of starchy seeds is about 13%, and oily seeds about 7%. The major effects of fungi are to:
 - decrease viability;
 - produce toxins that affect seed viability and germination;
 - increase heat production - important in large seed lots; and,
 - cause discoloration, mustiness, and caking.
- **Insects** — In hot, humid climates such as the Mid-Atlantic and South, mites, weevils, flour beetles, and borers can be a serious problem in stored seed, but if the seed is dried to 8% moisture content and the temperature reduced to (64 to 68°F (18 to 20°C), insects should not be a problem. At a moisture content of 15% and a temperature of 86 to 95°F (30 to 35°C), they can become very destructive. Mites will not survive when the relative humidity is below 60% (Bewley and Black, 1985).

Variety and harvest conditions:

Different varieties of a particular crop species may have different longevity when stored under the same conditions. This may be explained by differences in enzyme activity, or differences in the chemical constituents of unique varieties. For example, sweet corns are rich in simple sugars, whereas dent corns are high in complex carbohydrates. This explains why dent corn seed keeps longer than seed of sweet corn.

Harvest conditions may also affect longevity of seeds in storage. For example, under poor conditions of harvest, seed may have more fungi on the seed coat. Differences in harvest conditions are insignificant if storage conditions are good, but under adverse conditions, harvest differences can be very significant. (Bewley and Black, 1985).

Seed moisture levels required for long-term sealed storage:

Seed can be stored for long-term sealed storage provided that the seed moisture content is less than 8%, which means that the relative humidity must be kept below 35% (as shown in Figure 3 below).

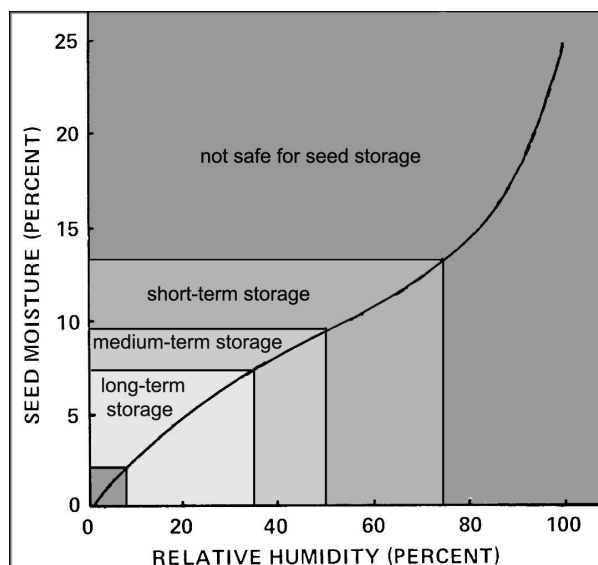

Figure 3. Length of seed storage in relation to seed moisture content and relative humidity. The data above are based on averages of different vegetable seed crops. Note that grain crops have higher seed moisture content than do oily seed crops. (adapted from Copeland, 1976; and Nakamura, 1958; with additions by the author)

For the Mid-Atlantic and South, seed must be dried with a desiccant in order to achieve the desired moisture level for long-term storage. When drying with silica gel according to the procedure described above, large seeds such as peas, beans, and corn will be dried to about 6 to 8% moisture content, and smaller seeds will dry down to about 3 to 5% moisture content, depending on the size of the seed and whether its primary food reserve is starch or oil. Seeds with a starchy food reserve retain a higher seed moisture content than oily seeds.

Table 1. Maximum seed moisture content for seeds stored in sealed containers. The seed moisture percentage of stored seed should not be higher than the values given below (USDA Federal Seed Act, 1976).

| Vegetable | Seed moisture (%) | Vegetable | Seed moisture (%) |
|------------------|-------------------|--------------|-------------------|
| Bean, common | 7.0 | Leek | 6.5 |
| Bean, Lima. | 7.0 | Lettuce | 5.5 |
| Beet | 7.5 | Muskmelon | 6.0 |
| Broccoli | 5.0 | Mustard | 5.0 |
| Brussels sprouts | 5.0 | Onion | 6.5 |
| Cabbage | 5.0 | Onion, Welsh | 6.5 |
| Carrot | 7.0 | Parsley | 6.5 |
| Cauliflower | 5.0 | Parsnip | 6.0 |
| Celeriac | 7.0 | Pea | 7.0 |
| Celery | 7.0 | Pepper | 4.5 |
| Chard, Swiss | 7.5 | Pumpkin | 6.0 |
| Chinese Cabbage | 5.0 | Radish | 5.0 |
| Chives | 6.5 | Rutabaga | 5.0 |
| Collards | 5.0 | Spinach | 8.0 |
| Corn, sweet | 8.0 | Squash | 6.0 |
| Cucumber | 6.0 | Tomato | 5.5 |
| Eggplant | 6.0 | Turnip | 5.0 |
| Kale | 5.0 | Watermelon | 6.5 |
| Kohlrabi | 5.0 | Unlisted | 6.0 |

Packaging materials and containers for seed storage:**➤ Materials for short-term storage:**

There are a wide variety of materials that can be used to store seed for short-term storage. Most of these are non-rigid materials such as cotton, burlap, paper, and composite materials such as multi-wall paper and plastic film, or polyethylene bags. Materials used for short-term storage are generally porous. They adequately contain and protect the seeds from mixing, but do not provide protection from moisture or loss of seed viability. Such materials are usually used for mechanically separating seed lots, and for transporting and shipping seed until the seed can be placed in environmentally controlled conditions for longer-term storage. Each type of packaging material has its own advantages and disadvantages. Burlap bags have the greatest strength, can be re-used many times, and can be stacked high without slipping of the stack. The strength of cotton bags is dependent on the thickness of the weave and thread, and the quality of the seams. Though not as strong or as tear-resistant as burlap, cotton bags can often be re-used, depending on the quality of the fabric. Bags made of woven plastic material also are fairly strong but tend to slip when piled high and are harder to close securely after the bag has been opened. Multi-wall bags are made of several layers of paper in a variety of types of construction. They have poor bursting strength when piled high or accidentally dropped, and if used repeatedly, they tend to become brittle along the folds and wear points. Cardboard boxes and cans, though expensive, are re-usable, good for stacking, and provide some protection against mechanical injury to seed and to infestation by seed storage insects. Flexible packaging that has a weave, whether it is burlap, cotton, or plastic offers little protection against seed storage pests such as grain moths. Consequently, seed stored in such woven bags may have to be inspected if an outbreak is detected in a particular seed bag. Seed storage insects are very good at locating small openings in bags or containers that are not well sealed.

For small lots of seed, paper bags such as lunch bags are inexpensive and adequate for storing seed, but the seams are not always reliable, and when used, the bags should be double or triple bagged to ensure integrity to prevent bursting. Other materials such cellophane, acetate, and 2- to 4-mil polyethylene zip lock bags may be used (provided the seed has dried adequately). If using polyethylene, it is best to use the 4-mil thickness, especially for heavy seeds. Plastics and thin films are not reliable moisture barriers, though such materials offer better moisture protection than paper.

➤ Materials for long-term storage:

Metal and glass containers, properly sealed to prevent the exchange of moisture and gas, are the most commonly used containers. They are the only reliable means of protecting seeds against humidity, insects, rodents, floods, and mechanical damage. Plastic should not be used for long-term storage.

For storing large quantities of seed, metal five-gallon cans fitted with a rubber gasketed lid and pressure ring are ideal for storing large seeds such as peas, beans, and corn. One-gallon jars are also excellent, provided that the lid has a gasketed seal. Some one-gallon jars have plastic lids that are flexible enough to form a tight seal when the lid is screwed tightly, but metal lids need a rubber gasket. Gaskets can be cut from sheets of neoprene rubber (available at hardware stores) or used automobile inner tubes. Though glass is breakable, it has the advantage of being transparent so that the contents can be easily inspected for insect damage (especially useful for detecting bean weevils, grain moths, and other seed pests). Metal and glass storage containers are available from a number of sources (Supplies and Equipment section). Glass canning jars are available in sizes ranging from ¼ pint to ½ gallon. One-gallon glass jars are often available free for the asking at restaurants, fast-food restaurants, and snack bars that purchase pickles, relish, mayonnaise, and a number of other food ingredients in bulk.

For storing small quantities of seed, ¼ and ½ pint jars are ideal, provided the rubber seal is in good condition. Baby food jars are often recommended, but again the seal should be in good condition. The seal can be ruined from seeds getting trapped between the rim of the jar and the lid; therefore jars should not be packed to the rim. Other materials that can be used are Seed Saver Vials™ which are made of a high-density polypropylene with a patented inner and outer valve that ensures an airtight seal. Another material, often used for seed banks, is a heat-sealable barrier pouch. Barrier pouches are a triple-laminate material made from paper, plastic, and foil. See the Supplies and Equipment section for suppliers. They are sealed with a heat sealer, or an iron set on “wool” setting.

When deciding on the type of storage container, it is often helpful to settle on a minimum number of standard sizes. If using canning jars, it is best to choose a particular brand name and style so that same-size and same-style containers have the same weight. This is very helpful in inventory control of seeds being held for long-term storage. Standardization of container style and weight makes it easy to obtain the weight of stored seed without actually removing the seed from the container and exposing to humid air. Once the weight of standard containers is known, it is easy to subtract that weight from the container of seed to obtain the weight of the seed.

➤ **Effect of different packaging materials on seeds in sealed storage:**

There is somewhat of a general conception among people new to saving seed, that plastic materials (for example, zip lock bags) are highly moisture impermeable. The conception is only partially true, as seen in Figure 4.

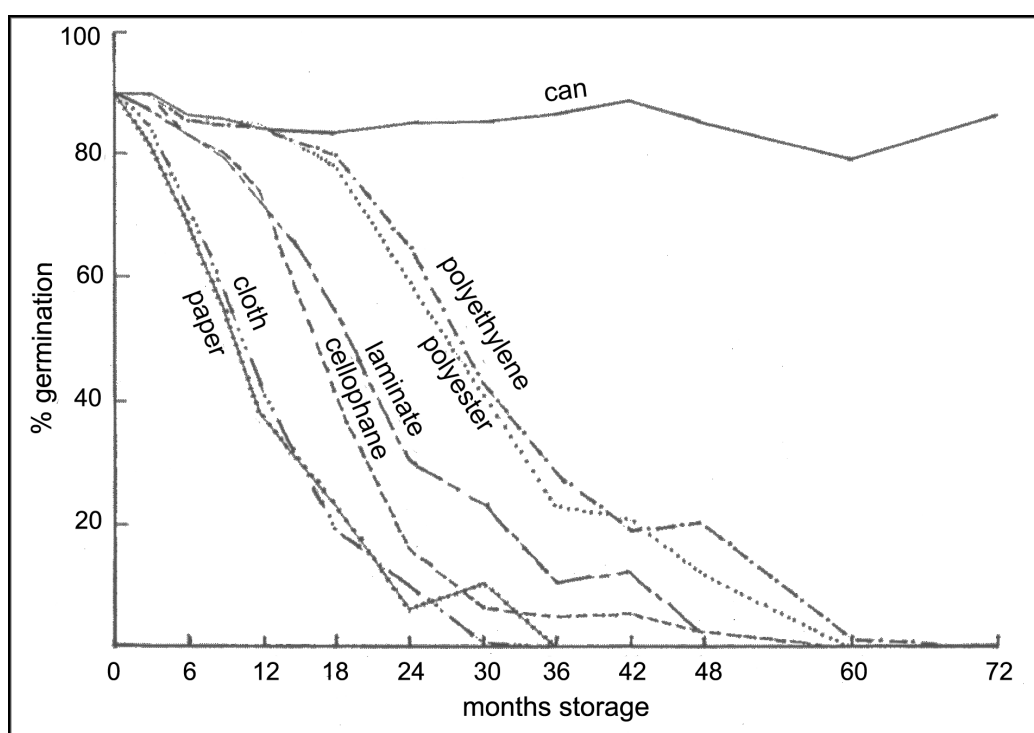

Figure 4. The effect of different types of seed storage containers on the germination percent of creeping red fescue seed (Grabe and Isely, 1969). Results do not take into account the thickness of the container.

SEED LONGEVITY

Relationship between viability and vigor:

Seed germination, generally measured by percentage, measures the number of seeds in a lot that can be expected to germinate and grow healthy plants. Seed vigor is defined by normal seedling morphology and the rate at which seeds germinate and grow in the early stages. Strong seed vigor has many advantages for the organic grower, as vigorous seeds are less likely to be overtaken by diseases, weeds, and insects than weak ones.

During the time that seed is held in storage, there is a gradual decline in germination and vigor. When a seed company holds seed in storage at ambient temperature, the seed is typically tested every six months to

a year, depending on the conditions of storage. Seed that is stored at 40°F (14°C), or at subfreezing temperatures is tested on a longer cycle depending on how the seed was dried and the temperature at which it was stored. Every time a germination test is done, the germination percent and test date is recorded on the stock container. What that label doesn't show is the degree of seedling vigor. There should be a germination test number on the label so that the test log can be consulted if there are concerns about vigor. Loss of seedling vigor is often apparent in the germination test. When the seeds take longer to germinate than usual, the seedlings are smaller, and sometimes malformed.

Information about the vigor of a variety can be partially inferred from the germination data if you are familiar with the general relationship between viability and vigor. The relationship between vigor and viability is illustrated by a sigmoid survival curve as shown in Figure 5. Note that the relationship between vigor and viability is similar except that vigor declines before viability. There are three distinct phases to this relationship: (1) the first when germination is approximately 80% or above, when seed is both vigorous and viable; (2) the second stage when deterioration progresses rapidly; and (3), the third stage when deterioration slows at approximately 20% or below, and all seeds slowly die. In my own experience from seed testing of vegetable varieties, when the germination drops to about 75%, I begin to have questions about the vigor of the seed lot. If I have questions about it, I may review the recency of the test result, the source of the seed lot, the year it was grown, the storage conditions, and then may consult the seed test log, or re-test the seed if concerns arise. It should be noted that the curve shown in this graph is a generalized curve, and that there are significant differences among varieties and types of seeds in regard to viability and vigor. Large differences in vigor and viability are more likely to show up under substandard storage conditions, especially when the relative humidity permits the growth of storage molds.

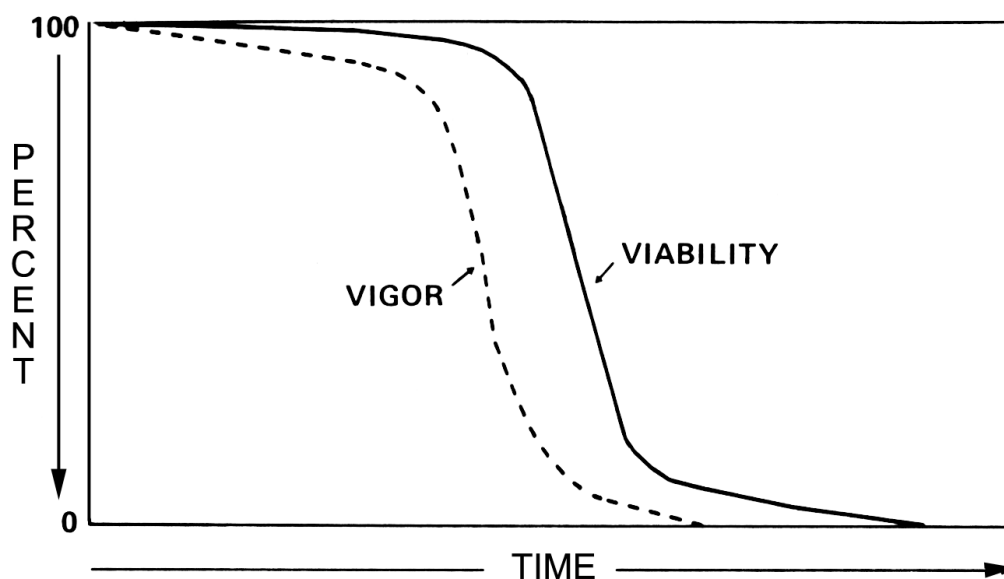

Figure 5. Relationship between the decline in vigor and viability over time (Harrington, 1972).

Expected life span of stored seed:

The chart below shows the expected lifespan of seed stored under good conditions (seed giving a good stand of plants at the normal seeding rate at the end of the storage period). The shaded column shows the total lifespan of seed stored under good conditions. Since the storage conditions are not specified in either case, the following are general guidelines.

| Vegetable | Years * good germ. | Years ** average lifespan | Vegetable | Years * good germ. | Years ** average lifespan |
|------------------|--------------------------|---------------------------------|--------------|--------------------------|---------------------------------|
| Asparagus | 3 | 8 | Kohlrabi | 3 | 10 |
| Bean | 3 | 10+ | Leek | 2 | 9 |
| Beet | 4 | 10+ | Lettuce | 6 | 9 |
| Broccoli | 3 | 10+ | Muskmelon | 5 | 10+ |
| Brussels sprouts | 4 | 10 | Mustard | 4 | 8 |
| Cabbage | 4 | 10 | N.Z. spinach | 3 | 8 |
| Cardoon | 5 | 9 | Okra | 2 | 10+ |
| Carrot | 3 | 10+ | Onion | 1 | 7 |
| Cauliflower | 4 | 10 | Parsley | 1 | 9 |
| Celeriac/celery | 3 | 10+ | Parsnip | 1 | 4 |
| Chard, Swiss | 4 | 10+ | Pea | 3 | 8 |
| Chervil | 3 | 6 | Pepper | 2 | 7 |
| Chicory | 4 | 10+ | Pumpkin | 4 | 10+ |
| Chinese cabbage | 3 | 7 | Radish | 5 | 10+ |
| Collard | 5 | | Rutabaga | 4 | 10+ |
| Corn | 2 | 4 | Salsify | 1 | 8 |
| Corn salad | 5 | 10 | Scorzoneria | 2 | 7 |
| Cress, garden | 5 | 9 | Sea kale | 1 | |
| Cress, water | 5 | 9+ | Sorrel | 4 | 7 |
| Cucumber | 5 | 10+ | Southern pea | 3 | 8 |
| Dandelion | 2 | 5 | Spinach | 3 | 7 |
| Eggplant | 4 | 10 | Squash | 4 | 10+ |
| Endive | 5 | 10+ | Tomato | 4 | 9 |
| Fennel | 4 | 7 | Turnip | 4 | 10+ |
| Kale | 4 | 10 | Watermelon | 4 | 10+ |

* (Lorenz and Maynard, 1980)

** (Vilmorin-Andrieux, 1856)

+ The plus sign indicates that the seed had not lost all its viability before the test was terminated.

SEED DORMANCY

Every type of seed goes through a period of dormancy, which is a mechanism for delaying germination until the seed is dispersed and exposed to favorable growing conditions. It is not evolutionarily advantageous for all seeds from the mother plant to germinate at the same time. Environmental conditions, such as drought, disease, and predation may wipe out a generation of seed. Dormancy provides a mechanism for seeds to be able to adapt to their environment by germinating at different times and under different conditions. It is not a mere resting state of a seed, but rather an active physiological state. Dormancy helps seeds to germinate at the proper time of year, temperature, pH, lighting conditions, nutrient levels, or other environmental conditions that affect survival. It allows weed seeds to remain ungerminated in the soil for many years, until the conditions are conducive to growth. Most vegetable crops have a long history of domestication, a selection process which has eliminated or reduced dormancy in many of our major food crops. Nevertheless, some of our common crops still exhibit some dormancy, and this poses a problem for seedsmen. For example, some varieties of brassicas, tomatoes, peppers, especially varieties with wild ancestry, may not germinate well, or at all, shortly after harvest. A period of dry storage may be required before the seeds germinate.

The process of artificially breaking dormancy is called conditioning. For 95% of seeds, the basis of dormancy is biochemical or physiological in nature, whereas for the remainder of dormant seeds, the cause for dormancy is an impermeable seed coat (Deno, 1993). The mechanism for breaking dormancy varies from

species to species (and even variety to variety) and most often involves drying (curing), exposure to light, leaching of chemical inhibitors, exposure to high or low temperature, or alternating temperatures. The germination rate of many agricultural seeds may be increased if exposed to alternations in daily temperature. For example, some herb seeds tested in the controlled conditions of a germination chamber do not germinate as well as seeds germinated outdoors in the same media. In some species, dormancy is broken by exposure to nitrate ions in the soil, and in others, exposure of seeds to gibberellins (plant hormone) produced by soil fungi. Seeds that are produced by fleshy fruits have dormancy broken by fermentation and leaching of the chemical inhibitors from the gelatinous coat surrounding the seed. Preharvest growing conditions can also affect dormancy. For example, lettuce grown under different conditions of water and nutrients exhibit differences in the amount of dormancy. Squash and pumpkins have the highest germination percentage when seed is harvested from fruit that is twenty days past peak ripeness.

In many instances, seed dormancy is released by dry storage. The seeds of crop species that exhibit dormancy after harvest can be released from dormancy within two to six months after harvest. This is important for some pepper varieties. If the seeds are frozen, the seeds remain dormant until they are subjected to above freezing temperatures for several months.

It is important for seed growers and seed purveyors to understand the dormancy characteristics of crops, especially in regard to germination testing. A seed grower testing the germination of a lot of freshly harvested seed may be surprised to discover that the tested seed doesn't germinate. Rather than assuming that seed is dead and needs to be discarded, it is important to test the possibility that the seed is dormant, and that the seed may need to be retested after a period of conditioning.

FEDERAL AND STATE SEED LAWS

Seed laws exist for the basic purpose of ensuring that seed is labeled truthfully. They serve to protect gardeners and farmers, and because seeds move from dealer to dealer they protect seedsmen as well. Effectively, anyone who handles seed in commerce is afforded protection of the law. When a particular variety is in short supply, seed dealers may legally sell low-quality seed, but the seed must be labeled as "below standard", and additional seed may need to be added to the container to compensate for the low germination. In most states, seed packets are not required to show the actual percentage germination unless the package weighs a pound or more. Other labeling requirements exist for some crops, especially grains, indicating the percentage of weed seed. Some crops have hard seeds - seeds that are impermeable to water during the usual germination period. When these crops are labeled, the percentage of hard seeds is included in the germination count. Another protection afforded by labeling is the specification that seeds that have been treated must be labeled as such. In addition, a dye must be added to the seed so that it can visually be identified as treated seed. Seed, that has been grown organically, must meet organic certification standards before the seed can be labeled as organic seed.

When growing seed for sale, you should contact the Department of Agriculture in your state to obtain a copy of the seed laws for your state. Certain crops such as cotton may require a permit to grow the crop. In Virginia for example, the state monitors boll weevils by placing traps in the field. Other states control the sale of seeds, which may be considered noxious weeds, and either forbids their sale or their importation into the state. State seed laws contain fairly similar requirements, so if you are meeting the requirements of the Federal Seed Act, very likely you are in compliance with state seed laws. Some states have different germination minimums for crops, but these differences pertain more to herbs and flowers than they do to vegetable seed.

Federal germination standards are specified in the Federal Seed Act. Some crops, such as peppers have a minimum germination standard of only 55%. Though this seems low, when dealing with varieties of peppers that have wild genes in their ancestry, germination in these varieties is lower and dormancy tends to be an issue. Over the years I discovered that many heirloom beans seem to germinate better than modern varieties of beans. In fact, the 1966 Virginia Seed Law gives a standard of 75% germination for a list of older varieties and a standard of 70% for newer varieties. Seed companies generally require their growers to produce seed with higher germination rate than that of federal standards because they need seeds with a long shelf life. A listing of the germination standards set for growers by Southern Exposure Seed Exchange and Garden Medicinals and Culinaris is found in Appendix B.

SEED TREATMENTS

The ideal seed treatment should be: (1) very effective against seed-borne pathogens, (2) relatively non-toxic to animals and plants, even if misused, (3) effective for a long time during seed storage, (4) easy to use, (5) acceptable according to the OMRI list of practices, and (6) economical. The hot water treatment method meets many of these criteria. Though not as easy to use as chemical treatments, it can be more effective and is non-toxic.

The purpose of the hot water treatment method is to submerge seed in water hot enough to kill the pathogen without damaging the seed embryo. When properly done the procedure is very effective, but there are some precautions to follow: (1) use only new, vigorous, high germination seed, (2) control the temperature of the process very carefully, since this is fundamental to success, (3) test the germination of the seed lot before and after treating the seeds, and (4) practice first on a small sample before treating a large batch of seeds. Although the germination of properly treated seed will not be significantly affected, the storage life of the seed may be shorter.

Equipment need for this process is as follows: (1) large metal pot and several smaller containers; (2) bags for seed made of muslin, cotton, or nylon (panty hose will do); (3) an accurate thermometer from a science supply house, and (4) sieve, colander, vegetable steamer, or hardware cloth cut in the same diameter as the inside of the pot.

The procedure is as follows:

1. Place the seeds loosely in a fabric bag, filling no more than half full, and then tie securely. Add a small weight, such as a bolt to help sink the seeds.
2. Set up the treatment container so that the bag of seed doesn't touch the bottom of the pot. There are several ways to keep the bag off the bottom: (a) suspend the seed bag on a vegetable steamer, (b) set the bag in a colander, or (c), cut a circle of hardware cloth and suspend it at least ½" off the bottom by using small stones.
3. Fill the treatment container about half full, and using an accurate thermometer, bring the water to the treatment temperature.
4. Pre-soak the seeds in water, between 100 to 105°F (38 to 41°C) for five to ten minutes to pre-warm the seeds.
5. Once the temperature in the treatment container is constant, add the bag of seed. While treating the seed, stir the water slowly and constantly, while keeping an eye on the temperature and the clock. An accurate thermometer is essential because temperatures one or two degrees too high can injure the seed, and one or two degrees too low will fail to kill the pathogen. To help adjust the temperature, cold or hot water can be added while stirring.
6. Remove the seed, and cool by dipping the bag briefly in lukewarm water, and then in cool water.
7. Open the bag and spread out the seed to dry on a hard surface or fine screen. Dry at room temperature using a fan for supplemental ventilation, and stir the seeds several times daily until dry.

For hot water treatment times for vegetable seed, see Appendix A.

GERMINATION TESTING

Basic procedure for doing your own tests:

Most growers prefer to sell seed wholesale and leave germination testing to the seed company that has the equipment and supplies necessary to do accurate testing. You can perform your own germination tests for the purpose of testing the germination of old seed lots, or testing new seed lots that you may want to store for some period of time. Tests that you do on your own may not necessarily be legal for the seed trade, but they will be accurate enough for your own use.

For supplies you will need blotters or thick paper towels, tweezers or forceps for picking up or placing seed, zip lock bags, a misting bottle, and perhaps plastic boxes used for honeycomb (for light-dependent germinators). As a substitute for a germination chamber you can place the seeds on top of a refrigerator or hot water heater.

To build a simple germination chamber, obtain an old student refrigerator (approximately two cubic feet capacity) and remove the compressor. Alternatively, an insulated plywood box can be used as a chamber. Cover any holes with caulk, duct tape, or other suitable material. For monitoring temperature, drill a hole in the side or top to insert the probe of a thermometer. A maximum-minimum thermometer is recommended because it records the temperature history and is useful for determining if the temperature has exceeded the desired range. For a heat source, use a 40-watt bulb in a porcelain fixture and wire it in series with a computer fan and dimmer switch to control the heating rate. The dimmer shouldn't be run below 75% of capacity because the computer fan may stall or not start up when the current is switched on. The electrical supply cord from the chamber is connected to a timer to give a 16-hour warm period at 86°F (30°C) and an 8-hour cool period (ambient room temperature).

To perform a simple germination test, count out 100 seeds and place them somewhat equidistant from each other, usually not closer than ½", spreading them out on the upper half of the moist blotter or paper towel. The bottom half of the blotter is folded over the top, and then the towel is folded over with a fold about every two to three inches and held in place loosely by a rubber band. The towels or blotters are then placed vertically in plastic trays refrigerator containers, which are placed in the germination chamber or suitable location. The trays or containers should be covered loosely with zip-lock or plastic bags to keep the moisture in the towels, but they should not be completely closed because seeds need air. Towels are inspected twice a day and misted as necessary. Most vegetable seeds germinate in about 7 to 14 days. During the first count remove the seeds that have germinated and when the final count is done, the remaining seeds are scored and the paper towel discarded. Seeds that require light are placed on blotter paper within plastic honey boxes. The light from the germination chamber will be sufficient to satisfy the light requirement. Some cool-weather crops such as lettuce should be germinated at room temperature. Most varieties of lettuce will not germinate above 80°F (27°C). Although a test of 100 seeds will give you a fairly reliable germination test, a test of 400 seeds will remove most of the statistical error and sampling error in testing.

Testing by laboratories:

For an accurate germination test, you should contact your state seed-testing laboratory to find out what is required in terms of fees (if any) and sample size for testing. Virginia requires a minimum 1000 seeds for a test. State seed testing laboratories and seed companies follow a strict protocol for testing each type of seed. Rules for testing seeds are available from the Association of Official Seed Analysts, Inc. (PMB #411, 1763 East University Blvd., Las Cruces, NM 88001). Their Web site is <http://www.aosaseed.com>.

GERMINATION ENHANCEMENT TECHNIQUES

There are several techniques that can be used to improve the germination of seed lots. These are especially useful when it is necessary to bring a lot of seed above the Federal germination standard.

Mixing seed lots of the same variety:

The easiest way to enhance germination is to combine two lots of germination tested seed, one having a high germination score and the other having a lower germination score. The two lots are thoroughly mixed and the new germination percentage is calculated. For example, mixing 600 grams of 90% germination seed with 400 grams of 70% germination seed yields 1000 grams of 82% germination seed. This technique might be used by a seed company in an effort to meet market demand when the seed is in short supply or to avoid discarding seed. If this technique is used, the seed lot with the lower germination should not be too low in vigor or germination, otherwise there will be too much variability in the stand of plants produced from such seed. This technique should not be used if one of the seed lots is significantly below Federal standard. The other concern is that organic growers should make certain that both lots are certified organic. The mixed seed is given a new lot identification number, but a record must be kept indicating the origin and germination data of the original seed lots.

Additional seed processing:

Types of seed that have been cleaned using winnowing as part of the seed cleaning process are candidates for these methods. Seeds of pumpkins, squash, melons, cucumbers, sunflowers, lettuce, and flower seed can be aggressively re-winnowed to remove lighter, immature seed that is not well filled out.

Such seed will be lighter than the good seed, which is denser and more resistant to being carried away by the air current during the cleaning process.

Brief microwave treatment:

When seeds are subjected to a brief exposure of microwaves they respond with enhanced germination. This treatment must be carefully controlled, is appropriate only for small seed lots, and is mainly used to help rescue low germination seed, especially seed of endangered varieties. I have successfully used this treatment on a lot of low-germination pepper seed, using an exposure time of 15 seconds to increase the germination by about 25%. Longer treatment times were not attempted. This method is not recommended for large seed lots because of the difficulty in obtaining equal microwave exposure in all areas of the treated seed lot. The procedure involves placing a thin layer of seed in the center of the microwave oven and microwaving for approximately 10 to 30 seconds depending on the size and water content of the seed. Sunflower seed, when subjected to 30 seconds of microwave treatment, germinates faster than non-microwaved seeds, but when microwaved for 60 seconds they fail to germinate. Microwave radiation selectively heats the water within the seed. In addition, fats and oils are heated, though to a lesser extent (Bloomfield, 2004). Fava beans microwaved for 30 seconds show a seven-fold increase in certain nutrients (Randhir and Shetty, 2003). The heating process speeds up metabolism and there is some speculation that the heating may affect the permeability of the lipid-containing membranes, thereby causing cellular changes leading to enhanced germination. If the seed is heated too rapidly or too long, certain biological molecules (proteins) such as enzymes are denatured, losing their enzymatic activity, and the seed is killed. Seeds that have a low seed moisture content may need longer exposures than seeds with a high seed moisture content. For most seed treatments the initial exposure should be anywhere from 10 to 15 seconds, with additional trials at 10 or 15 second increments. If this procedure is used for germination enhancement, some preliminary experiments should be done to determine the optimum exposure for germination enhancement for a particular type of seed. The effect of microwaves on seed germination is not well documented, so reports of any experiments are welcome and should be forwarded to the author. Because microwaving seed constitutes a seed treatment, check with your organic certifier before planting the seed or using it in commerce. In any case, microwaved seed needs to be retested after treatment.

Other techniques:

There are a number of other techniques that can be used to enhance seed germination. These include use of seed coatings, sodium hypochlorite treatment, and in the case of dormant seeds use of scarification and stratification. These techniques are beyond the scope of this publication, but it is worth noting that certain recently harvested vegetable seeds, especially pepper seed, can exhibit dormancy or slow germination. Post-harvest dormancy in most peppers can be overcome by curing the seed for at least six weeks at a temperature of 70 to 80°F (21 to 27°C).

SEED STATISTICS

Information about seeds per ounce, sowing rates, germination data, and Federal germination standards for vegetable crops are found in Appendix B. It is important to note that the measure of seeds per ounce, and the sowing rate can be quite variable, depending on (1) variety characteristics; (2) pre-harvest growing conditions, and (3), seed processing procedures. Some types of vegetables, notably squash, beans, corn and beets, exhibit considerable variation in seed size that is genetically determined. Seed size is further influenced by pre-harvest growing conditions. Considering that 95% of the dry weight of seed is storage material, conditions during growth may influence the amount of storage material produced. Seed crops harvested too early may have a higher percentage of immature seeds, which are smaller in size. Seed processing procedures also affect seed size. For example, the screening and winnowing process may leave behind a disproportionate number of large or small seeds depending on how the seeds were processed. Special seed processing procedures such as de-fuzzing tomato seed will have a large effect on the seed count per ounce.

LABELING AND RECORD KEEPING

Labeling:

During the growing season, through planting, harvest, and processing it is essential that all crops be properly labeled. This is especially important once the crop is harvested, as many seeds may look alike. Labels should be on every container and should travel through every step of process and cleaning. While this may seem obvious, it is very easy to think that you will remember what was in a particular container, but it is surprisingly easy for several hours to slip by, and then to get confused about the identity of a particular seed lot. Also, when seed is harvested at different times from the same variety, it is also useful to put a date on the label. This can be important later on if there are questions about purity due to improper isolation, disease, or other issues that arise retrospectively.

Record keeping:

You should keep a log of most everything you do with your crops, including information about planting times and location for each variety, lot number and source of seed planted, germination percent or comments about germination and vigor, number of plants transplanted (useful for calculating seed yields later), maturity data, yield data, insect problems, organic fertilizers and amendments, and other data which may become useful later. Your garden or farm log is also important for organic certification.

Detailed records should be kept in a card file or computer database regarding variety characteristics and performance. Such data should include an accession number and information about seed source, lot number, year last grown, maturity data, plant characteristics (growth habit, yield, productivity, color and shape of fruit), disease resistance or susceptibility, and taste comparisons with other varieties. Record keeping can be time consuming, so from the perspective of time management it is important to keep in mind that the real value of information is information re-use.

SHIPPING SEEDS

Prior to shipment:

All seed must be thoroughly dry prior to shipment. Typically the minimum recommended time between harvest and shipment is six weeks. During the last three weeks of this period, the seed should be stored in a climate-controlled environment to allow the seed to cure. This means that seeds shipped in the late summer should be cured in an air-conditioned environment, and seeds shipped in winter should be stored in a heated environment prior to shipment.

Containers for shipping:

Small lots of seeds can be packed in ordinary envelopes, provided that all edges of the envelope are sealed with tape, and the envelope placed inside a second envelope. The seams of the inner envelope must be sealed so that seeds do not sift out of the envelope during shipment. Zip-lock bags are available in various sizes, but it is best to use 4 mil thick bags. Zip-lock bags are fine to use, but if the bag is to hold several ounces of seed, especially heavy or sharp seed (for example, cucumber seed) it is best to double bag these. The zipped edge should be folded over and taped or banded to help prevent accidental opening of the zipped edge. All air should be sucked out of the bags to avoid popping. The seeds should then be packed in a cardboard box or a padded mailer.

Large seeds, such as peas, beans, and corn can be packed in grocery bags, but must be triple-bagged, and taped securely to prevent breakage of the bag during shipment. The rule of thumb I use for shipping is that the container and contents should be able to survive a ten-foot drop without damage to the container or contents. This is about the approximate maximum distance a package might be thrown by a package handler. Remember: if bags break during shipment it may be impossible to tell one variety from another and the seed will be worthless. There should be enough padding inside the container so that there is no rattling or shifting of contents. During the process of delivery, the packing material will become compacted. Newspaper tends to compact too much, so stiffer materials such as crumpled grocery bags are

recommended. One of the most enlightening lessons of running a mail-order business is opening a package that has been shipped across country and back. That provides great feedback about your skill in packing.

Mark each seed container with your name and the variety name on a slip of paper, both inside the container and on the outside of the seed container. Mark on the outside of the shipping package in large letters "Perishable - Live Seeds Keep Cool and Dry." Include shipping address and a packing list with the package. Address labels should always be covered with clear packing tape; otherwise the package conveyor belt may snag the edge of the label and rip it off the package. All seams need to be securely taped. Sometimes packages can be left outside in the rain by the delivery person, so you don't want water entering an open seam.

Appendix A: Hot water treatment times (in minutes) for vegetable seed.

| Vegetable | Temperature of water treatment bath | | | |
|------------------|-------------------------------------|-----|-----------|-----|
| | 118 | 120 | 122 | 125 |
| Broccoli | | | 20' | |
| Brussel sprouts | | | 25' | |
| Cabbage | | | 25' | |
| Cabbage, Chinese | | | 20' | |
| Carrot | | | 15' - 20' | |
| Cauliflower | | | 20' | |
| Celery, celeriac | 30' | | | |
| Collard | | | 20' | |
| Cucumber | | | 20' | |
| Eggplant | | | 25' | |
| Garlic (cloves) | | 20' | | |
| Kale | | | 20' | |
| Kohlrabi | | | 20' | |
| Lettuce | 30' | | | |
| Mustard | | | 15' | |
| Pepper | | | | 30' |
| Radish | | | 15' | |
| Rutabaga | | | 20' | |
| Spinach | | | 25' | |
| Tomato | | | 25' | |
| Turnip | | | 20' | |

Note: There is some variation in the literature regarding the recommended treatment temperature and times. This raises the question of whether the recommended temperature and time differences can be explained by differences in elevation where the original research was performed. (For example, it takes longer to boil an egg at 5,000 feet than it does at sea level.) If treatments are being performed at high elevations, perhaps over 1,000 feet, it may be necessary to raise the treatment temperature by one or two degrees, or increasing the treatment time (but testing may be required to check for damage to seed treated at higher temperatures or greater times).

APPENDIX B: Vegetable seed data, germination information, and federal standards

| Vegetable | Seeds per ounce ^a Seeding rate (lb/acre) ^b | | Germination | | | | |
|---------------------|--|----------|---|--|-------------------------------------|---|--|
| | | | Time at 68 - 86°F (days) ^a | Temp. range opt. °F ^c | Temp. optimum °F ^c | Federal standard (%) ^d | Grower standard (%) ^e |
| Asparagus | 700 | 2 - 3 | 7 - 21 | 60 - 85 | 75 | 70 | 75 |
| Bean, asparagus | 225 | 20 - 40 | 5 - 8 | | | 75 | 80 |
| Bean, broad | 20 - 50 | 60 - 80 | 4 - 14 | | | 75 | 80 |
| Bean, Lima bush | 25 - 75 | 40 - 60 | 5 - 9 | 65 - 85 | 85 | 70 | 80 |
| Bean, Lima pole | 25 - 75 | 30 - 40 | 5 - 9 | 65 - 85 | 85 | 70 | 80 |
| Bean, runner | 25 - 30 | 50 - 70 | 5 - 9 | | | 75 | 80 |
| Bean, snap bush | 100 - 125 | 70 - 90 | 5 - 8 | 60 - 85 | 80 | 70 | 80 |
| Bean, snap pole | 100 - 125 | 20 - 40 | 5 - 8 | 60 - 85 | 80 | 70 | 80 |
| Beet | 1,600 | 6 - 10 | 3 - 14 | 55 - 85 | 85 | 65 | 75 |
| Broccoli | 9,000 | ½ - 1-½ | 3 - 10 | | | 75 | 80 |
| Brussels sprouts | 9,000 | ½ - 1-½ | 3 - 10 | | | 70 | 80 |
| Cabbage | 9,000 | ½ - 1-½ | 3 - 10 | | | 75 | 80 |
| Cabbage, Chinese | 9,000 | 1 - 2 | 3 - 7 | | | 75 | 80 |
| Cardoon | 700 | 4 - 5 | 7 - 21 | | | 60 | 70 |
| Carrot | 23,000 | 2 - 4 | 6 - 21 | 45 - 85 | 80 | 55 | 65 |
| Cauliflower | 9,000 | ½ - 1-½ | 3 - 10 | 45 - 85 | 80 | 75 | 80 |
| Celeriac/celery | 72,000 | 1 - 2 | 10 - 21 | 60 - 70 | 70 | 55 | 70 |
| Chard, Swiss | 1,600 | 6 - 8 | 3 - 14 | 50 - 85 | 85 | 65 | 75 |
| Chicory | 27,000 | 3 - 5 | 5 - 14 | | | 65 | 75 |
| Collards | 9,000 | 2 - 4 | 3 - 10 | | | 80 | 85 |
| Corn, sweet | 120 - 180 | 10 - 15 | 4 - 7 | 60 - 95 | 95 | 75 | 85 |
| Cucumber | 1,100 | 2 - 3 | 3 - 7 | 60 - 95 | 95 | 80 | 85 |
| Dandelion | 35,000 | 2 | 7 - 21 | | | 60 | 60 |
| Eggplant | 6,500 | 2 | 7 - 14 | 75 - 90 | 85 | 60 | 70 |
| Endive | 27,000 | 3 - 4 | 5 - 14 | | | 70 | 75 |
| Fennel, Florence | 7,000 | 3 | | | | 60 | 60 |
| Kale | 9,000 | 2 - 4 | 3 - 10 | | | 75 | 80 |
| Kohlrabi | 9,000 | 3 - 5 | 3 - 10 | | | 75 | 80 |
| Leek | 11,000 | 4 | 6 - 14 | | | 60 | 70 |
| Lettuce | 25,000 | 1 - 3 | 7 | 40 - 80 | 75 | 80 | 85 |
| Muskmelon | 1,300 | 2 - 4 | 4 - 10 | 75 - 95 | 90 | 75 | 80 |
| Mustard | 15,000 | 3 - 5 | 3 - 7 | | | 75 | 80 |
| New Zealand spinach | 350 | 15 | 5 - 28 | | | 40 | 60 |
| Okra | 500 | 6 - 8 | 4 - 10 | 70 - 95 | 95 | 50 | 75 |
| Onion | 8,500 | 3 - 4 | 6 - 10 | 50 - 95 | 75 | 70 | 75 |
| Parsley | 18,500 | 3 - 4 | 11 - 28 | 50 - 85 | 75 | 60 | 65 |
| Parsnip | 12,000 | 3 - 5 | 6 - 28 | 50 - 70 | 65 | 60 | 70 |
| Pea | 90 - 175 | 90 - 220 | 5 - 8 | 40 - 75 | 75 | 80 | 85 |
| Pepper | 4,500 | 2 - 4 | 6 - 14 | 65 - 95 | 85 | 55 | 75 |
| Pumpkin | 100 - 300 | 1 | 4 - 7 | 70 - 95 | 95 | 75 | 80 |
| Radish | 2,500 | 10 - 20 | 4 - 6 | 45 - 90 | 80 | 75 | 80 |
| Rutabaga | 12,000 | 1 - 2 | 3 - 14 | | | 75 | 80 |
| Salsify | 1,900 | 8 - 10 | 5 - 10 | | | 75 | 80 |
| Sorrel | 30,000 | 2 - 3 | 3 - 14 | | | 65 | 75 |
| Southern pea | 225 | 20 - 40 | 5 - 8 | | | 75 | 80 |
| Soybean | 175 - 350 | 20 - 40 | 5 - 8 | | | 75 | 80 |
| Spinach | 2,800 | 10 - 15 | 7 - 21 | 45 - 75 | 70 | 60 | 70 |
| Squash | 120 - 400 | 2 - 6 | 4 - 7 | 70 - 95 | 95 | 75 | 80 |
| Tomato | 11,500 | ½ - 1-½ | 5 - 14 | 60 - 85 | 85 | 75 | 80 |
| Turnip | 15,000 | 1 - 2 | 3 - 7 | 60 - 105 | 85 | 80 | 85 |
| Watermelon | 200 - 300 | 1 - 3 | 4 - 14 | 70 - 95 | 95 | 70 | 80 |

References: ^a (Stefferd, 1961), ^b (Lorenz and Maynard, 1980), ^c (Harrington, 1954),
^d (USDA Federal Seed Act, 1976), ^e Suggested minimum for growers (McCormack, J.H.).

Appendix C: Basic seed cleaning equipment

The following is a list of basic and more specialized equipment for seed growers and seed savers. The following items will suffice for just about any seed cleaning needs. Seed-cleaning screens should measure 12" x 12" outside dimension so that they can nest or be placed on top of each other to be used in combination.

Various sizes of hardware cloth are used to make the most essential screens. The 1/8" and 3/8" sizes are a little harder to find but some hardware stores carry these sizes.

Specialty seed cleaning screens can be ordered from specialty companies. See also the Supplies and Equipment section. Specialty screens are noted with an asterisk in the table below.

Parts of electronic cabinets or housing are very useful. These are the cabinets on certain air-cooled or ventilated electronic equipment. Parts of the cabinet may have round or oblong holes. Also various types of strainers, grease-splatter screens, that keep oil from splattering from a frying pan, are useful. Visit the house wares department of stores and antique shops where you'll find an assortment of useful shapes and sizes.

| Framed seed screens (12" x 12") & seed cleaning equipment | Comments |
|---|--|
| Cloth-covered wood frame | Useful for cleaning beets, chard and other seeds which roll and leave chaff behind |
| * Copper wire 20x22 | Useful for lettuce and some herbs and other small seeds |
| * Copper wire 24x24 | Useful for lettuce and some herbs and other small seeds |
| * Copper wire 4 x18 | Useful for small seeds |
| * Copper wire 6x18 | Useful for small seeds |
| * Copper wire 6x20 | Useful for small seeds |
| Diamond metal lath 1/2" x 3/8" | Can be used in place of 1/4" hardware cloth, for beans but hardware cloth is best |
| Hardware cloth 1/2" | Good all-purpose screen for large seeds for removing large rough chaff |
| Hardware cloth 3/8" | Good all-purpose screen for large seeds for removing large rough chaff |
| Hardware cloth 1/4" | Good all-purpose screen for large seeds, especially beans, and pre-screening |
| Hardware cloth 1/8" | Good all-purpose screen for medium and small seeds. Very useful size |
| Round #12 (3/16") deep tray | Electronic parts cabinet, good for sizing and cleaning beans and corn |
| * Round 10/64 | Round holes are very useful. |
| * Round 5.5/64 | Round holes are very useful. |
| Round electronic 3/16" | Electronic parts cabinet -very useful size for brassica and other small round seeds |
| * Slotted 3x5/16 | Good for oblong and long seed - very useful size |
| Window screen | Handy and common but not used much since other specialty screens do the trick |
| Mixing bowls, set of various sizes, stainless steel | An assortment of 6 or more sizes from 4" to 16" diameter with varying depth/slopes |
| Vacuum "Hoover" | Inexpensive hand-held models. Hose can be reversed to blow air. Good for beans, corn, and cucurbits. |
| Grain mill with custom stand | Excellent for processing hot pepper seeds. |
| Squeeze® strainer and accessories | Can be used for processing tomato seed if you want to save the juice |
| Hair dryer | Just about any will do, look for at least two speed options and cool or warm air only. Not necessary to remove heating element unless there is only a hot air setting. |
| Fan or squirrel cage blower | Fan useful for winnowing if a vacuum is not available. |

SOURCES OF SUPPLIES AND EQUIPMENT

The following list of suppliers is provided because some of the equipment and supplies mentioned in this manual may be difficult to locate.

Germination papers and blotters:

Anchor Paper Company, 480 Broadway Street, St. Paul, MN 55101 (651) 298-1311
www.anchorpaper.com

Pollination bags:

Lawson Bag Company, P.O. Box 8577, Northfield, IL 60093 (847) 446-8812

Seed germination testing manuals:

Association of Official Seed Analysts, Inc., MB #411, 1763 East University Blvd., Las Cruces, NM 88001
www.aosaseed.com.

Seed screens:

Abundant Life Seed Foundation, P.O. Box 772, Port Townsend, WA 98368 (360) 385-5660
www.abundantlifeseed.com

Seedburo Equipment Company, 1022 W. Jackson Blvd., Chicago, IL 60607 (312) 738-3700
www.seedburo.com

Seed saving containers, supplies and equipment:

Garden Medicinals and Culinaries, P.O. Box 320, Earlysville, VA 22936 (434) 964-9113
www.gardenmedicinals.com

Southern Exposure Seed Exchange, P.O. Box 460, Mineral, VA 23117 (540) 894-9480
www.southernexposure.com

SELECTED BIBLIOGRAPHY AND LITERATURE CITED

Bewley, J. D. and M. Black. 1985. Seeds: Physiology of Development and Germination. Plenum Press, NY.

Bloomfield, L.A. 2004. How Things Work: The Physics of Everyday Life. <http://howthingswork.virginia.edu> (June 1)

Copeland, L. O. 1976. Principles of Seed Science and Technology. Burgess Publishing Co., Minneapolis, MN.

Deno, N. 1993. Seed Germination Theory and Practice (2nd ed.). (self-published) State College, PA.

Grabe, D. F. and D. Isely. 1969. "Seed storage in moisture-resistant packages" Seed World (Jan 24.) p. 4.

Harrington, J.F. 1954. Vegetable seed germination temperatures. Agricultural Extension leaflet, University of California, Davis.

Harrington, J. F. 1960. "Drying, storing, and packaging seed to maintain germination, vigor" Seedman's Digest 11(1): 16 56-57, 64, 66, 68.

Harrington, J. F. 1972. Seed storage and longevity. In Kozlowski, T. T., Seed Biology 3: 145-245. NY.

Justin, O. L. and L. N. Bass. 1978. Principles and Practices of Seed Storage. Agriculture Handbook Number 506, U.S.D.A. Agricultural Research Service, Washington, DC.

Logsdon, Gene. 1977 *Small-Scale Grain Raising*. Rodale Press, Emmaus, PA.

Lorenz, O. A. and D. N. Maynard. 1980. *Knott's Handbook for Vegetable Growers* (2nd edition). John Wiley & Sons, NY.

Navazio, J. 2003. "Seed-born diseases" (lecture handout). Organic Seed Alliance. Port Townsend, WA.

Randhir, R.O. and K. Shetty. 2003. Microwave-elicited pentose phosphate pathway for stimulation of L-DOPA, phenolics and antioxidant activity in fava bean (*Vicia faba*) sprouts for Parkinson's diet. http://ift.confex.com/ift/2003/techprogram/paper_17111.htm.

Stefferd, A. (ed.) 1961. *Seeds: The Yearbook of Agriculture*. U.S. Department of Agriculture, Washington, DC.

Vilmorin-Andrieux, M. M. 1856. *The Vegetable Garden: Illustrations, Descriptions, and Culture*. John Murray (Publishers), Ltd., London.

Weber, L.E. et al. 1986. *Amaranth Grain Production Guide*. Rodale Research Center, Rodale Press, Kutztown, PA.

CREDITS



Front matter illustration is from page 310 (Stefferd, 1961)

DISTRIBUTION AND LICENSING INFORMATION



Attribution - Non-Commercial - No-Derivs 2.0

Although the author retains the copyright to this document, you are free to copy, distribute, and display this work under the following conditions:

-  **Attribution:** You must give the original author credit including the name, date, and version of this publication.
-  **Non-commercial:** You may not use this work for commercial purposes.
-  **Non-derivative works:** You may not alter, transform, or build upon this work.

For any reuse or distribution, you must include this notice, and make clear to others the license terms of this work.

Any of these conditions can be waived if you get permission from the copyright holder.

Your fair use and other rights are in no way affected by the above.

This is a summary of the Creative Commons Attribution-NonCommercial-NoDerivs License. To view the legal copy of this license, visit <http://creativecommons.org/licenses/by-nc-nd/2.0/> or send a letter to Creative Commons, 559 Nathan Abbott Way, Stanford, California 94305, USA.